



CAM AND GROOVE COUPLINGS

A

Cam and Groove Couplings



Size	Aluminum		Brass		316 SS		304 SS	
	Part #	List Price	Part #	List Price	Part #	List Price	Part #	List Price
1/2"	A 050IAL	--	A 050IBR	--	A 050SS	--	A 050SS304	--
1/2 x 3/4"	A 05075IAL	--	A 05075IBR	--	A 05075SS	--	--	--
3/4"	A 075IAL	--	A 075IBR	--	A 075SS	--	A 075SS304	--
1"	A 100IAL	--	A 100IBR	--	A 100SS	--	A 100SS304	--
1-1/4"	A 125IAL	--	A 125IBR	--	A 125SS	--	A 125SS304	--
1-1/2"	A 150IAL	--	A 150IBR	--	A 150SS	--	A 150SS304	--
2"	A 200IAL	--	A 200IBR	--	A 200SS	--	A 200SS304	--
2-1/2"	A 250IAL	--	A 250IBR	--	A 250SS	--	A 250SS304	--
3"	A 300IAL	--	A 300IBR	--	A 300SS	--	A 300SS304	--
4"	A 400IAL	--	A 400IBR	--	A 400SS	--	A 400SS304	--
5"	A 500ASTMAL	--	B 500ASTMBR	--	A 500SS	--	A 500SS304	--
6"	A 600IAL	--	A 600IBR	--	A 600SS	--	A 600SS304	--
8"	A 800IALNAE	--	--	--	--	--	--	--
8"	A 800IALPTK	--	--	--	--	--	--	--
10"	A 1000IAL	--	--	--	--	--	--	--
12"	A 1200IAL	--	--	--	--	--	--	--

Size	Plated Iron		Poly		Nyglass	
	Part #	List Price	Part #	List Price	Part #	List Price
1/2" x 3/4"	--	--	A 050075PP	--	--	--
3/4"	--	--	A 075PP	--	A 075NG	--
1"	A 100CI	--	A 100PP	--	A 100NG	--
1-1/4"	--	--	**A 125PP	--	**A 125NG	--
1-1/2"	A 150CI	--	**A 150PP	--	**A 150NG	--
2"	A 200CI	--	A 200PP	--	A 200NG	--
3"	A 300CI	--	A 300PP	--	A 300NG	--
4"	A 400CI	--	A 400PP	--	A 400NG	--
5"	A 500CI	--	--	--	--	--
6"	A 600CI	--	--	--	--	--

** Available as: 1-1/4 adapter or coupler X 1-1/4 NPT
 Please specify: 1-1/2 adapter or coupler X 1-1/4 NPT
 1-1/2 adapter or coupler X 1-1/2 NPT



Cam and Groove Couplings

B Female Coupler
X
Male NPT



All Couplers Supplied
With Buna-N Gaskets

Size	Aluminum		Brass		316 SS		304 SS	
	Part #	List Price	Part #	List Price	Part #	List Price	Part #	List Price
1/2"	B 050IAL	--	B 050IBR	--	B 050SS	--	B 050SS304	--
1/2 x 3/4"	B 05075IAL	--	B 05075IBR	--	B 05075SS	--	--	--
3/4"	B 075IAL	--	B 075IBR	--	B 075SS	--	B 075SS304	--
1"	B 100IAL	--	B 100IBR	--	B 100SS	--	B 100SS304	--
1-1/4"	B 125IAL	--	B 125IBR	--	B 125SS	--	B 125SS304	--
1-1/2"	B 150IAL	--	B 150IBR	--	B 150SS	--	B 150SS304	--
2"	B 200IAL	--	B 200IBR	--	B 200SS	--	B 200SS304	--
2-1/2"	B 250IAL	--	B 250IBR	--	B 250SS	--	B 250SS304	--
3"	B 300IAL	--	B 300IBR	--	B 300SS	--	B 300SS304	--
4"	B 400IAL	--	B 400IBR	--	B 400SS	--	B 400SS304	--
5"	B 500ASTMAL	--	B 500ASTMBR	--	B 500SS	--	B 500SS304	--
6"	B 600IAL	--	B 600IBR	--	B 600SS	--	B 600SS304	--
8"	B 800IALPTK	--	--	--	--	--	--	--

Size	Plated Iron		Poly		Nyglass	
	Part #	List Price	Part #	List Price	Part #	List Price
1/2" x 3/4"	--	--	B 050075PP	--	--	--
3/4"	--	--	B 075PP	--	B 075NG	--
1"	B 100CI	--	B 100PP	--	B 100NG	--
1-1/4"	--	--	**B 125PP	--	**B 125NG	--
1-1/2"	B 150CI	--	**B 150PP	--	**B 150NG	--
2"	B 200CI	--	B 200PP	--	B 200NG	--
3"	B 300CI	--	B 300PP	--	B 300NG	--
4"	B 400CI	--	B 400PP	--	B 400NG	--
5"	B 500CI	--	--	--	--	--
6"	B 600CI	--	--	--	--	--

Note: All Cam & Groove Stainless Bodies are 316 Investment with 304 Handles.
All 4" Poly and Ny-Glass couplers have 4 handles.

** Available as: 1-1/4 adapter or coupler X 1-1/4 NPT
Please specify: 1-1/2 adapter or coupler X 1-1/4 NPT
1-1/2 adapter or coupler X 1-1/2 NPT



CAM AND GROOVE COUPLINGS

A

Cam and Groove Couplings

C Female Coupler
X
Hose Shank



All Couplers Supplied
With Buna-N Gaskets

Size	Aluminum		Brass		316 SS		304 SS	
	Part #	List Price	Part #	List Price	Part #	List Price	Part #	List Price
1/2"	C 050IAL	--	C 050IBR	--	C 050SS	--	C 050SS304	--
1/2 x 3/4"	C 05075IAL	--	C 05075IBR	--	C 05075SS	--	--	--
3/4"	C 075IAL	--	C 075IBR	--	C 075SS	--	C 075SS304	--
1"	C 100IAL	--	C 100IBR	--	C 100SS	--	C 100SS304	--
1-1/4"	C 125IAL	--	C 125IBR	--	C 125SS	--	C 125SS304	--
1-1/2"	C 150IAL	--	C 150IBR	--	C 150SS	--	C 150SS304	--
2"	C 200IAL	--	C 200IBR	--	C 200SS	--	C 200SS304	--
2-1/2"	C 250IAL	--	C 250IBR	--	C 250SS	--	C 250SS304	--
3"	C 300IAL	--	C 300IBR	--	C 300SS	--	C 300SS304	--
4"	C 400IAL	--	C 400IBR	--	C 400SS	--	C 400SS304	--
5"	C 500ASTMAL	--	C 500ASTMBR	--	C 500SS	--	C 500SS304	--
6"	C 600IAL	--	C 600IBR	--	C 600SS	--	C 600SS304	--
8"	C 800IALNAE	--	--	--	--	--	--	--
8"	C 800IALPTK	--	--	--	--	--	--	--
10"	C 1000IAL	--	--	--	--	--	--	--
12"	C 1200IAL	--	--	--	--	--	--	--

Size	Plated Iron		Poly		Nyglass	
	Part #	List Price	Part #	List Price	Part #	List Price
1/2" x 3/4"	--	--	C 050075PP	--	--	--
3/4"	--	--	C 075PP	--	C 075NG	--
1"	C 100CI	--	C 100PP	--	C 100NG	--
1-1/4"	--	--	**C 125PP	--	**C 125NG	--
1-1/2"	C 150CI	--	**C 150PP	--	**C 150NG	--
2"	C 200CI	--	C 200PP	--	C 200NG	--
3"	C 300CI	--	C 300PP	--	C 300NG	--
4"	C 400CI	--	C 400PP	--	C 400NG	--
5"	C 500CI	--	--	--	--	--
6"	C 600CI	--	--	--	--	--

Note: All Cam & Groove Stainless Bodies are 316 Investment with 304 Handles.
All 4" Poly and Ny-Glass couplers have 4 handles.

** Available as: 1-1/4 adapter or coupler X 1-1/4 NPT
Please specify: 1-1/2 adapter or coupler X 1-1/4 NPT
1-1/2 adapter or coupler X 1-1/2 NPT



Cam and Groove Couplings

D Female Coupler
X
Female NPT



All Couplers Supplied
With Buna-N Gaskets

Size	Aluminum		Brass		316 SS		304 SS	
	Part #	List Price	Part #	List Price	Part #	List Price	Part #	List Price
1/2"	D 050IAL	--	D 050IBR	--	D 050SS	--	D 050SS304	--
1/2 x 3/4"	D 05075IAL	--	D 05075IBR	--	D 05075SS	--	--	--
3/4"	D 075IAL	--	D 075IBR	--	D 075SS	--	D 075SS304	--
1"	D 100IAL	--	D 100IBR	--	D 100SS	--	D 100SS304	--
1-1/4"	D 125IAL	--	D 125IBR	--	D 125SS	--	D 125SS304	--
1-1/2"	D 150IAL	--	D 150IBR	--	D 150SS	--	D 150SS304	--
2"	D 200IAL	--	D 200IBR	--	D 200SS	--	D 200SS304	--
2-1/2"	D 250IAL	--	D 250IBR	--	D 250SS	--	D 250SS304	--
3"	D 300IAL	--	D 300IBR	--	D 300SS	--	D 300SS304	--
4"	D 400IAL	--	D 400IBR	--	D 400SS	--	D 400SS304	--
5"	D 500ASTMAL	--	D 500ASTMBR	--	D 500SS	--	D 500SS304	--
6"	D 600IAL	--	D 600IBR	--	D 600SS	--	D 600SS304	--
8"	D 800IALNAE	--	--	--	--	--	--	--
8"	D 800IALPTK	--	--	--	--	--	--	--
10"	D 1000IAL	--	--	--	--	--	--	--
12"	D 1200IAL	--	--	--	--	--	--	--

Size	Plated Iron		Poly		Nyglass	
	Part #	List Price	Part #	List Price	Part #	List Price
1/2" x 3/4"	--	--	D 050075PP	--	--	--
3/4"	--	--	D 075PP	--	D 075NG	--
1"	D 100CI	--	D 100PP	--	D 100NG	--
1-1/4"	--	--	**D 125PP	--	**D 125NG	--
1-1/2"	D 150CI	--	**D 150PP	--	**D 150NG	--
2"	D 200CI	--	D 200PP	--	D 200NG	--
3"	D 300CI	--	D 300PP	--	D 300NG	--
4"	D 400CI	--	D 400PP	--	D 400NG	--
5"	D 500CI	--	--	--	--	--
6"	D 600CI	--	--	--	--	--

Note: All Cam & Groove Stainless Bodies are 316 Investment with 304 Handles.
All 4" Poly and Ny-Glass couplers have **4 handles**.

** Available as: 1-1/4 adapter or coupler X 1-1/4 NPT
Please specify: 1-1/2 adapter or coupler X 1-1/4 NPT
1-1/2 adapter or coupler X 1-1/2 NPT



CAM AND GROOVE COUPLINGS

A

Cam and Groove Couplings

E

**Male Adapter
X
Hose Shank**



Size	Aluminum		Brass		316 SS		304 SS	
	Part #	List Price	Part #	List Price	Part #	List Price	Part #	List Price
1/2"	E 050IAL	--	E 050IBR	--	E 050SS	--	E 050SS304	--
1/2 x 3/4"	E 05075IAL	--	E 05075IBR	--	E 05075SS	--	--	--
3/4"	E 075IAL	--	E 075IBR	--	E 075SS	--	E 075SS304	--
1"	E 100IAL	--	E 100IBR	--	E 100SS	--	E 100SS304	--
1-1/4"	E 125IAL	--	E 125IBR	--	E 125SS	--	E 125SS304	--
1-1/2"	E 150IAL	--	E 150IBR	--	E 150SS	--	E 150SS304	--
2"	E 200IAL	--	E 200IBR	--	E 200SS	--	E 200SS304	--
2-1/2"	E 250IAL	--	E 250IBR	--	E 250SS	--	E 250SS304	--
3"	E 300IAL	--	E 300IBR	--	E 300SS	--	E 300SS304	--
4"	E 400IAL	--	E 400IBR	--	E 400SS	--	E 400SS304	--
5"	E 500ASTMAL	--	E 500ASTMBR	--	E 500SS	--	E 500SS304	--
6"	E 600IAL	--	E 600IBR	--	E 600SS	--	E 600SS304	--
8"	E 800IALNAE	--	--	--	--	--	--	--
8"	E 800IALPTK	--	--	--	--	--	--	--
10"	E 1000IAL	--	--	--	--	--	--	--
12"	E 1200IAL	--	--	--	--	--	--	--

Size	Plated Iron		Poly		Nyglass	
	Part #	List Price	Part #	List Price	Part #	List Price
1/2" x 3/4"	--	--	E 050075PP	--	--	--
3/4"	--	--	E 075PP	--	E 075NG	--
1"	E 100CI	--	E 100PP	--	E 100NG	--
1-1/4"	--	--	**E 125PP	--	**E 125NG	--
1-1/2"	E 150CI	--	**E 150PP	--	**E 150NG	--
2"	E 200CI	--	E 200PP	--	E 200NG	--
3"	E 300CI	--	E 300PP	--	E 300NG	--
4"	E 400CI	--	E 400PP	--	E 400NG	--
5"	E 500CI	--	--	--	--	--
6"	E 600CI	--	--	--	--	--



Cam and Groove Couplings



Size	Aluminum		Brass		316 SS		304 SS	
	Part #	List Price	Part #	List Price	Part #	List Price	Part #	List Price
1/2"	F 050IAL	--	F 050IBR	--	F 050SS	--	F 050SS304	--
1/2 x 3/4"	F 05075IAL	--	F 05075IBR	--	F 05075SS	--	--	--
3/4"	F 075IAL	--	F 075IBR	--	F 075SS	--	F 075SS304	--
1"	F 100IAL	--	F 100IBR	--	F 100SS	--	F 100SS304	--
1-1/4"	F 125IAL	--	F 125IBR	--	F 125SS	--	F 125SS304	--
1-1/2"	F 150IAL	--	F 150IBR	--	F 150SS	--	F 150SS304	--
2"	F 200IAL	--	F 200IBR	--	F 200SS	--	F 200SS304	--
2-1/2"	F 250IAL	--	F 250IBR	--	F 250SS	--	F 250SS304	--
3"	F 300IAL	--	F 300IBR	--	F 300SS	--	F 300SS304	--
4"	F 400IAL	--	F 400IBR	--	F 400SS	--	F 400SS304	--
5"	F 500ASTMAL	--	F 500ASTMBR	--	F 500SS	--	F 500SS304	--
6"	F 600IAL	--	F 600IBR	--	F 600SS	--	F 600SS304	--
8"	F 800IALNAE	--	--	--	--	--	--	--
8"	F 800IALPTK	--	--	--	--	--	--	--
10"	F 1000IAL	--	--	--	--	--	--	--
12"	F 1200IAL	--	--	--	--	--	--	--

Size	Plated Iron		Poly		Nyglass	
	Part #	List Price	Part #	List Price	Part #	List Price
1/2" x 3/4"	--	--	F 050075PP	--	--	--
3/4"	--	--	F 075PP	--	F 075NG	--
1"	F 100CI	--	F 100PP	--	F 100NG	--
1-1/4"	--	--	**F 125PP	--	**F 125NG	--
1-1/2"	F 150CI	--	**F 150PP	--	**F 150NG	--
2"	F 200CI	--	F 200PP	--	F 200NG	--
3"	F 300CI	--	F 300PP	--	F 300NG	--
4"	F 400CI	--	F 400PP	--	F 400NG	--
5"	F 500CI	--	--	--	--	--
6"	F 600CI	--	--	--	--	--



CAM AND GROOVE COUPLINGS

A

Cam and Groove Couplings

DC



**All Couplers Supplied
With Buna-N Gaskets**

Dust Cap Coupler

Size	Aluminum		Brass		316 SS		304 SS	
	Part #	List Price	Part #	List Price	Part #	List Price	Part #	List Price
1/2"	DC 050IAL	--	DC 050IBR	--	DC 050SS	--	DC 050SS304	--
3/4"	DC 075IAL	--	DC 075IBR	--	DC 075SS	--	DC 075SS304	--
1"	DC 100IAL	--	DC 100IBR	--	DC 100SS	--	DC 100SS304	--
1-1/4"	DC 125IAL	--	DC 125IBR	--	DC 125SS	--	DC 125SS304	--
1-1/2"	DC 150IAL	--	DC 150IBR	--	DC 150SS	--	DC 150SS304	--
2"	DC 200IAL	--	DC 200IBR	--	DC 200SS	--	DC 200SS304	--
2-1/2"	DC 250IAL	--	DC 250IBR	--	DC 250SS	--	DC 250SS304	--
3"	DC 300IAL	--	DC 300IBR	--	DC 300SS	--	DC 300SS304	--
4"	DC 400IAL	--	DC 400IBR	--	DC 400SS	--	DC 400SS304	--
5"	DC 500ASTMAL	--	DC 500ASTMBR	--	DC 500SS	--	DC 500SS304	--
6"	DC 600IAL	--	DC 600IBR	--	DC 600SS	--	DC 600SS304	--
8"	DC 800IALNAE	--	--	--	--	--	--	--
8"	DC 800IALPTK	--	--	--	--	--	--	--
10"	DC 1000IAL	--	--	--	--	--	--	--
12"	DC 1200IAL	--	--	--	--	--	--	--

Size	Plated Iron		Poly		Nyglass	
	Part #	List Price	Part #	List Price	Part #	List Price
3/4"	--	--	DC 075PP	--	DC 075NG	--
1"	DC 100CI	--	DC 100PP	--	DC 100NG	--
1-1/4"	--	--	**DC 125PP	--	**DC 125NG	--
1-1/2"	DC 150CI	--	**DC 150PP	--	**DC 150NG	--
2"	DC 200CI	--	DC 200PP	--	DC 200NG	--
3"	DC 300CI	--	DC 300PP	--	DC 300NG	--
4"	DC 400CI	--	DC 400PP	--	DC 400NG	--
5"	DC 500CI	--	--	--	--	--
6"	DC 600CI	--	--	--	--	--

Note: All Seal Fast Cam & Groove Stainless Bodies are 316 Investment with 304 Handles.
 * Dust Caps and Dust Plugs are not designed for pressure applications.

** Available as: 1-1/4 adapter or coupler X 1-1/4 NPT
 Please specify: 1-1/2 adapter or coupler X 1-1/4 NPT
 1-1/2 adapter or coupler X 1-1/2 NPT



Cam and Groove Couplings



DP Dust Plug Adapter

Size	Aluminum		Brass		316 SS		304 SS	
	Part #	List Price	Part #	List Price	Part #	List Price	Part #	List Price
1/2"	DP 050IAL	--	DP 050IBR	--	DP 050SS	--	DP 050SS304	--
3/4"	DP 075IAL	--	DP 075IBR	--	DP 075SS	--	DP 075SS304	--
1"	DP 100IAL	--	DP 100IBR	--	DP 100SS	--	DP 100SS304	--
1-1/4"	DP 125IAL	--	DP 125IBR	--	DP 125SS	--	DP 125SS304	--
1-1/2"	DP 150IAL	--	DP 150IBR	--	DP 150SS	--	DP 150SS304	--
2"	DP 200IAL	--	DP 200IBR	--	DP 200SS	--	DP 200SS304	--
2-1/2"	DP 250IAL	--	DP 250IBR	--	DP 250SS	--	DP 250SS304	--
3"	DP 300IAL	--	DP 300IBR	--	DP 300SS	--	DP 300SS304	--
4"	DP 400IAL	--	DP 400IBR	--	DP 400SS	--	DP 400SS304	--
5"	DP 500ASTMAL	--	DP 500ASTMBR	--	DP 500SS	--	DP 500SS304	--
6"	DP 600IAL	--	DP 600IBR	--	DP 600SS	--	DP 600SS304	--
8"	DP 800IALNAE	--	--	--	--	--	--	--
8"	DP 800IALPTK	--	--	--	--	--	--	--
10"	DP 1000IAL	--	--	--	--	--	--	--
12"	DP 1200IAL	--	--	--	--	--	--	--

Size	Plated Iron		Poly		Nyglass	
	Part #	List Price	Part #	List Price	Part #	List Price
3/4"	--	--	DP 075PP	--	DP 075NG	--
1"	DP 100CI	--	DP 100PP	--	DP 100NG	--
1-1/4"	--	--	**DP 125PP	--	**DP 125NG	--
1-1/2"	DP 150CI	--	**DP 150PP	--	**DP 150NG	--
2"	DP 200CI	--	DP 200PP	--	DP 200NG	--
3"	DP 300CI	--	DP 300PP	--	DP 300NG	--
4"	DP 400CI	--	DP 400PP	--	DP 400NG	--
5"	DP 500CI	--	--	--	--	--
6"	DP 600CI	--	--	--	--	--

* Dust Caps and Dust Plugs are not designed for pressure applications.

** Available as: 1-1/4 adapter or coupler X 1-1/4 NPT
Please specify: 1-1/2 adapter or coupler X 1-1/4 NPT
1-1/2 adapter or coupler X 1-1/2 NPT

Seal Fast Self Locking Couplers

B Female Coupler X Male NPT 	Size	Aluminum		Brass		Stainless Steel	
		Part #	List Price	Part #	List Price	Part #	List Price
	1"	B 100ALSK	--	B 100BRSK	--	B 100SSK	--
	1-1/2"	B 150ALSK	--	B 150BRSK	--	B 150SSK	--
	2"	B 200ALSK	--	B 200BRSK	--	B 200SSK	--
	2-1/2"	B 250ALSK	--	B 250BRSK	--	B 250SSK	--
	3"	B 300ALSK	--	B 300BRSK	--	B 300SSK	--
	4"	B 400ALSK	--	B 400BRSK	--	B 400SSK	--

C Female Coupler X Hose Shank 	Size	Aluminum		Brass		Stainless Steel	
		Part #	List Price	Part #	List Price	Part #	List Price
	1"	C 100ALSK	--	C 100BRSK	--	C 100SSK	--
	1-1/2"	C 150ALSK	--	C 150BRSK	--	C 150SSK	--
	2"	C 200ALSK	--	C 200BRSK	--	C 200SSK	--
	2-1/2"	C 250ALSK	--	C 250BRSK	--	C 250SSK	--
	3"	C 300ALSK	--	C 300BRSK	--	C 300SSK	--
	4"	C 400ALSK	--	C 400BRSK	--	C 400SSK	--

D Female Coupler X Female NPT 	Size	Aluminum		Brass		Stainless Steel	
		Part #	List Price	Part #	List Price	Part #	List Price
	1"	C 100ALSK	--	C 100BRSK	--	C 100SSK	--
	1-1/2"	C 150ALSK	--	C 150BRSK	--	C 150SSK	--
	2"	C 200ALSK	--	C 200BRSK	--	C 200SSK	--
	2-1/2"	C 250ALSK	--	C 250BRSK	--	C 250SSK	--
	3"	C 300ALSK	--	C 300BRSK	--	C 300SSK	--
	4"	C 400ALSK	--	C 400BRSK	--	C 400SSK	--

DC *Dust Cap Coupler 	Size	Aluminum		Brass		Stainless Steel	
		Part #	List Price	Part #	List Price	Part #	List Price
	1"	DC 100ALSK	--	DC 100BRSK	--	DC 100SSK	--
	1-1/2"	DC 150ALSK	--	DC 150BRSK	--	DC 150SSK	--
	2"	DC 200ALSK	--	DC 200BRSK	--	DC 200SSK	--
	2-1/2"	DC 250ALSK	--	DC 250BRSK	--	DC 250SSK	--
	3"	DC 300ALSK	--	DC 300BRSK	--	DC 300SSK	--
	4"	DC 400ALSK	--	DC 400BRSK	--	DC 400SSK	--

DA 		DD 	Size	Part #	List Price
			2"	DA 200SSK	--
			3"	DA 300SSK	--
<p>DA 3020SSK 3" Coupler x 2" Adapter</p> <p>DA 3020-1SSK 3" Coupler x 2" Adapter w/ 1/2" Tap</p> <p>Female X Female Coupler With Auto-Lock Handles</p>					

* Dust Caps and Dust Plugs are not designed for pressure applications.

* With auto-lock handles

Crimp Cam and Groove w/ Interlock

C

Have Interlocking Groove to be Used With Crimp Ferrules



Seal Fast Crimp Cam and Groove couplings are to be used with the Seal Fast Ferrules and Crimps Sleeves on pages 54-57 of this catalog. They are designed with an Interlock System which allows the Ferrule to be permanently attached to the coupling

Size	Aluminum		Brass		316 SS	
	Part #	List Price	Part #	List Price	Part #	List Price
1"	C 100ALC	--	C 100BRC	--	C 100SSC	--
1-1/2"	C 150ALC	--	C 150BRC	--	C 150SSC	--
2"	C 200ALC	--	C 200BRC	--	C 200SSC	--
3"	C 300ALC	--	C 300BRC	--	C 300SSC	--
4"	C 400ALC	--	C 400BRC	--	C 400SSC	--
6"	C 600ALC	--	C 600BRC	--	C 600SSC	--

E

Have Interlocking Groove to be Used With Crimp Ferrules



Seal Fast Crimp Cam and Groove couplings are to be used with the Seal Fast Ferrules and Crimps Sleeves on pages 54-57 of this catalog. They are designed with an Interlock System which allows the Ferrule to be permanently attached to the coupling

Size	Aluminum		Brass		316 SS	
	Part #	List Price	Part #	List Price	Part #	List Price
1"	E 100ALC	--	E 100BRC	--	E 100SSC	--
1-1/2"	E 150ALC	--	E 150BRC	--	E 150SSC	--
2"	E 200ALC	--	E 200BRC	--	E 200SSC	--
3"	E 300ALC	--	E 300BRC	--	E 300SSC	--
4"	E 400ALC	--	E 400BRC	--	E 400SSC	--
6"	E 600ALC	--	E 600BRC	--	E 600SSC	--

Butt Weld To Cam and Groove



Adapter By Socket Weld
316 Stainless

AW

Size	Part #	Bore	List Price
2"	AW 200SSI	2.390"	--
3"	AW 300SSI	3.530"	--
4"	AW 400SSI	4.530"	--



Coupler By Socket Weld
316 Stainless

DW

Size	Part #	Bore	List Price
2"	DW 200SSI	2.390"	--
3"	DW 300SSI	3.530"	--
4"	DW 400SSI	4.530"	--

Seal Fast Cam and Groove

A Female NPT X Male Adapter	Size	356 T6 Alloy		Brass		Banjo Poly	
		Part #	List Price	Part #	List Price	Part #	List Price
	3/4"	A 075AL	--	A 075BR	--	075A PP	--
	1"	A 100AL	--	A 100BR	--	100A PP	--
	1-1/4"	A 125AL	--	A 125BR	--	*125A PP	--
	1-1/2"	A 150AL	--	A 150BR	--	150A PP	--
	2"	A 200AL	--	A 200BR	--	200A PP	--
	2-1/2"	A 250AL	--	A 250BR	--	--	--
	3"	A 300AL	--	A 300BR	--	300A PP	--
	4"	A 400AL	--	A 400BR	--	400A PP	--
	5"	A 500AL	--	A 500BR	--	--	--
6"	A 600AL	--	A 600BR	--	--	--	

B Female Coupler X Male NPT	Size	356 T6 Alloy		Brass		Banjo Poly	
		Part #	List Price	Part #	List Price	Part #	List Price
	3/4"	B 075AL	--	B 075BR	--	075B PP	--
	1"	B 100AL	--	B 100BR	--	100B PP	--
	1-1/4"	B 125AL	--	B 125BR	--	*125B PP	--
	1-1/2"	B 150AL	--	B 150BR	--	150B PP	--
	2"	B 200AL	--	B 200BR	--	200B PP	--
	2-1/2"	B 250AL	--	B 250BR	--	--	--
	3"	B 300AL	--	B 300BR	--	300B PP	--
	4"	B 400AL	--	B 400BR	--	400B PP	--
	5"	B 500AL	--	B 500BR	--	--	--
6"	B 600AL	--	B 600BR	--	--	--	

C Female Coupler X Hose Shank	Size	356 T6 Alloy		Brass		Banjo Poly	
		Part #	List Price	Part #	List Price	Part #	List Price
	3/4"	C 075AL	--	C 075BR	--	075C PP	--
	1"	C 100AL	--	C 100BR	--	100C PP	--
	1-1/4"	C 125AL	--	C 125BR	--	*125C PP	--
	1-1/2"	C 150AL	--	C 150BR	--	150C PP	--
	2"	C 200AL	--	C 200BR	--	200C PP	--
	2-1/2"	C 250AL	--	C 250BR	--	--	--
	3"	C 300AL	--	C 300BR	--	300C PP	--
	4"	C 400AL	--	C 400BR	--	400C PP	--
	5"	C 500AL	--	C 500BR	--	--	--
6"	C 600AL	--	C 600BR	--	--	--	

D Female Coupler X Female NPT	Size	356 T6 Alloy		Brass		Banjo Poly	
		Part #	List Price	Part #	List Price	Part #	List Price
	3/4"	D 075AL	--	D 075BR	--	075D PP	--
	1"	D 100AL	--	D 100BR	--	100D PP	--
	1-1/4"	D 125AL	--	D 125BR	--	*125D PP	--
	1-1/2"	D 150AL	--	D 150BR	--	150D PP	--
	2"	D 200AL	--	D 200BR	--	200D PP	--
	2-1/2"	D 250AL	--	D 250BR	--	--	--
	3"	D 300AL	--	D 300BR	--	300D PP	--
	4"	D 400AL	--	D 400BR	--	400D PP	--
	5"	D 500AL	--	D 500BR	--	--	--
6"	D 600AL	--	D 600BR	--	--	--	

Seal Fast Cam and Groove

<p>E Male Adapter X Hose Shank</p> 	Size	356 T6 Alloy		Brass		Banjo Poly	
		Part #	List Price	Part #	List Price	Part #	List Price
	3/4"	E 075AL	--	E 075BR	--	075E PP	--
	1"	E 100AL	--	E 100BR	--	100E PP	--
	1-1/4"	E 125AL	--	E 125BR	--	*125E PP	--
	1-1/2"	E 150AL	--	E 150BR	--	150E PP	--
	2"	E 200AL	--	E 200BR	--	200E PP	--
	2-1/2"	E 250AL	--	E 250BR	--	--	--
	3"	E 300AL	--	E 300BR	--	300E PP	--
	4"	E 400AL	--	E 400BR	--	400E PP	--

<p>F Male Adapter X Male NPT</p> 	Size	356 T6 Alloy		Brass		Banjo Poly	
		Part #	List Price	Part #	List Price	Part #	List Price
	3/4"	F 075AL	--	F 075BR	--	075F PP	--
	1"	F 100AL	--	F 100BR	--	100F PP	--
	1-1/4"	F 125AL	--	F 125BR	--	*125F PP	--
	1-1/2"	F 150AL	--	F 150BR	--	150F PP	--
	2"	F 200AL	--	F 200BR	--	200F PP	--
	2-1/2"	F 250AL	--	F 250BR	--	--	--
	3"	F 300AL	--	F 300BR	--	300F PP	--
	4"	F 400AL	--	F 400BR	--	400F PP	--

<p>*DC Dust Cap Coupler</p> 	Size	356 T6 Alloy		Brass		Banjo Poly	
		Part #	List Price	Part #	List Price	Part #	List Price
	3/4"	DC 075AL	--	DC 075BR	--	075DC PP	--
	1"	DC 100AL	--	DC 100BR	--	100DC PP	--
	1-1/4"	DC 125AL	--	DC 125BR	--	*125DC PP	--
	1-1/2"	DC 150AL	--	DC 150BR	--	150DC PP	--
	2"	DC 200AL	--	DC 200BR	--	200DC PP	--
	2-1/2"	DC 250AL	--	DC 250BR	--	--	--
	3"	DC 300AL	--	DC 300BR	--	300DC PP	--
	4"	DC 400AL	--	DC 400BR	--	400DC PP	--

<p>*DP Dust Plug Adapter</p> 	Size	356 T6 Alloy		Brass		Banjo Poly	
		Part #	List Price	Part #	List Price	Part #	List Price
	3/4"	DP 075AL	--	DP 075BR	--	075DP PP	--
	1"	DP 100AL	--	DP 100BR	--	100DP PP	--
	1-1/4"	DP 125AL	--	DP 125BR	--	*125DP PP	--
	1-1/2"	DP 150AL	--	DP 150BR	--	150DP PP	--
	2"	DP 200AL	--	DP 200BR	--	200DP PP	--
	2-1/2"	DP 250AL	--	DP 250BR	--	--	--
	3"	DP 300AL	--	DP 300BR	--	300DP PP	--
	4"	DP 400AL	--	DP 400BR	--	400DP PP	--





BSP Tapered and Flanged Adapters and Couplers

A Tapered Female BSP X Male Adapter 	Size	Aluminum		316 Stainless Steel	
		Part #	List Price	Part #	List Price
	1-1/2"	A 150IALBSP	--	150A SSBSP	--
	2"	A 200IALBSP	--	200A SSBSP	--
	3"	A 300IALBSP	--	300A SSBSP	--
	4"	A 400IALBSP	--	400A SSBSP	--
6"	A 600IALBSP	--	--	--	

B Tapered Female Coupler X Male BSP 	Size	Aluminum		316 Stainless Steel	
		Part #	List Price	Part #	List Price
	1-1/2"	B 150IALBSP	--	150B SSBSP	--
	2"	B 200IALBSP	--	200B SSBSP	--
	3"	B 300IALBSP	--	300B SSBSP	--
	4"	B 400IALBSP	--	400B SSBSP	--
6"	B 600IALBSP	--	--	--	

D Tapered Female Coupler X Female BSP 	Size	Aluminum		316 Stainless Steel	
		Part #	List Price	Part #	List Price
	1-1/2"	D 150IALBSP	--	150D SSBSP	--
	2"	D 200IALBSP	--	200D SSBSP	--
	3"	D 300IALBSP	--	300D SSBSP	--
	4"	D 400IALBSP	--	400D SSBSP	--
6"	D 600IALBSP	--	--	--	

F Tapered Male Adapter X Male BSP 	Size	Aluminum		316 Stainless Steel	
		Part #	List Price	Part #	List Price
	1-1/2"	F 150IALBSP	--	150F SSBSP	--
	2"	F 200IALBSP	--	200F SSBSP	--
	3"	F 300IALBSP	--	300F SSBSP	--
	4"	F 400IALBSP	--	400F SSBSP	--
6"	F 600IALBSP	--	--	--	

FA 	150# Flanged Adapter 316 SS			FC 	150# Flanged Coupler 316SS		
	Size	Part #	List Price		Size	Part #	List Price
	2"	FA 200SS	--		2"	FC 200SS	--
	3"	FA 300SS	--		3"	FC 300SS	--
	4"	FA 400SS	--		4"	FC 400SS	--
6"	FA 600SS	--	6"	FC 600SS	--		

Replacement Handles

All Seal Fast cam arms are supplied complete with pins and spring steel finger rings. All brass, aluminum, and cast iron standard couplers and dust caps are supplied with brass or zinc alloy handles unless otherwise specified. Stainless and poly supplied with stainless steel handle

NOTE: Finger Rings are supplied on Cam Arms of Coupler Sizes 1-1/4" thru 5".

LOCKING CLIPS					Plated Steel SC100 List Price \$				Stainless Steel SC100SS List Price \$			
Size	Handle, Ring, and Pin				Handle Only				Ring		Pin	
	Brass Part #	List Price	Stainless Part #	List Price	Brass Part #	List Price	Stainless Part #	List Price	Part #	List Price	Part #	List Price
3/4"	HRP 075BR	--	HRP 075SS	--	H 075BR	--	H 075SS	--	--	--	P 075SS	--
1"	HRP 100BR	--	HRP 100SS	--	H 100BR	--	H 100SS	--	R 100	--	P 100SS	--
1-1/4"	HRP 200BR	--	HRP 200SS	--	H 200BR	--	H 200SS	--	R 200	--	P 200SS	--
1-1/2"	HRP 200BR	--	HRP 200SS	--	H 200BR	--	H 200SS	--	R 200	--	P 200SS	--
2"	HRP 200BR	--	HRP 200SS	--	H 200BR	--	H 200SS	--	R 200	--	P 200SS	--
2-1/2"	HRP 200BR	--	HRP 200SS	--	H 200BR	--	H 200SS	--	R 200	--	P 200SS	--
3"	HRP 300BR	--	HRP 300SS	--	H 300BR	--	H 300SS	--	R 300	--	P 300SS	--
4"	HRP 400BR	--	HRP 400SS	--	H 400BR	--	H 400SS	--	R 400	--	P 300SS	--
5"	HRP 500BR	--	HRP 500SS	--	H 500BR	--	--	--	R 500	--	P 300SS	--
6"	HRP 600BR	--	HRP 600SS	--	H 600BR	--	H 600SS	--	--	--	P 600PS**	--
8"	HRP 800BR	--	--	--	H 800BR	--	--	--	--	--	P 800PS**	--



Self Locking Handle			
Size	Part #	List Price	
1"	H100SK	--	
2"	H200SK	--	
3"	H300SK	--	



Replacement Handle for Locking Cap			
Size	Part #	List Price	
2"	LH 200SS	--	
3"	LS 300SS	--	
4"	LH 400SS	--	

***NOTE REGARDING GASKETS:** All SFI couplers are supplied with Buna-N as standard. However, this sealing compound may not be compatible with all applications.

STANDARD SIZES AND THREADS The size indicated for a coupler or adapter is the nominal size of pipe or hose to which it connects. Standard sizes for Seal Fast adapters and couplers are 1/2", 3/4", 1", 1-1/4", 1-1/2", 2", 2-1/2", 3", 4", 5", 6" and 8". Threaded parts are furnished with tapered pipe threads (NPT).

DUST CAPS AND DUST PLUGS Dust Caps and Dust Plugs are not designed for pressure application. Caps and Plugs must be chain or cable constrained at all times.

MAXIMUM PRESSURES FOR ALL METALS

1/2"	125 psi
3/4" through 4"	150 psi
5" through 6"	75 psi
8"	20 psi

*Recommendations based on use of mating fittings at ambient temperature of 70° F with standard Buna-N seal installed. For use at elevated temperatures or other unusual operating conditions, consult SFI.

Warning: Working pressure may vary depending on how the couplings are attached to the hose assembly. Before operation, always check the hose assembly for proper attachment and that couplings are in working order.

MAXIMUM PRESSURES FOR BANJO Polypropylene, Import Propylene, and Nyglass

At 0° F	
1/2" through 2"	100 psi
3" through 4"	75 psi

At 70° F	
1/2" through 2"	125 psi
3" through 4"	75 psi

At 150 °F	
1/2" through 2"	70 psi
3" through 4"	75 psi



90° Aluminum Couplers and 45° Couplers

	Female Coupler x Shank				Female Coupler x Male Adapter		
	Size	Part #	List Price		Size	Part #	List Price
	2"	C200AL90	--		2"	DA200AL90	--
	3"	C300AL90	--		3"	DA300AL90	--
	4"	C400AL90	--	4"	DA400AL90	--	
C				DA			

	Female Coupler x Shank		
	Size	Part #	List Price
	3"	DA30045AL	--

Polypropylene 90° Cam and Groove

	Male Adapter x Female NPT				Male Adapter x Female NPT		
	Size	Part #	List Price		Size	Part #	List Price
	1-1/2"	A15090PP	--		1-1/2"	B15090PP	--
	2"	A20090PP	--	2"	B20090PP	--	
A 90°				B 90°			

	Male Adapter x Female NPT				Male Adapter x Female NPT		
	Size	Part #	List Price		Size	Part #	List Price
	1-1/2"	C15090PP	--		1-1/2"	D15090PP	--
	2"	C20090PP	--	2"	D20090PP	--	
C 90°				D 90°			

	Male Adapter x Female NPT				Male Adapter x Female NPT		
	Size	Part #	List Price		Size	Part #	List Price
	1-1/2"	E15090PP	--		1-1/2"	F15090PP	--
	2"	E20090PP	--	2"	F20090PP	--	
E 90°				F 90°			

 <p>CL</p>	Female Coupler x Hose Shank w/ Notched Collar		
	Size	Stainless Steel Part #	List Price
	1-1/2"	150CL SS	--
	2"	200CL SS	--
	3"	300CL SS	--
4"	400CL SS	--	
Couplings used with Notched Ferrule			

 <p>EL</p>	Male Adapter x Hose Shank w/ Notched Collar		
	Size	Stainless Steel Part #	List Price
	1-1/2"	150EL SS	--
	2"	200EL SS	--
	3"	300EL SS	--
4"	400EL SS	--	
Couplings used with Notched Ferrule			

Velcro Fasteners for Cam and Groove





Size	Part #	List Price
1" - 1-1/2"	CGS12	--
2" - 3"	CGS18	--
4" - 5"	CGS24	--
6" - 8"	CGS36	--

Adapters and Reducing Adapters

 <p>SA</p>	Size	Aluminum Part #	List Price	Brass Part #	List Price	Stainless Part #	List Price
	1"	SA 100AL	--	SA 100BR	--	100AA SS	--
	1-1/4"	SA 125AL	--	SA 125BR	--	125AA SS	--
	1-1/2"	SA 150AL	--	SA 150BR	--	150AA SS	--
	1-1/2" x 2"	SA 1520AL	--	--	--	1520AA SS	--
	2"	SA 200AL	--	SA 200BR	--	200AA SS	--
	2-1/2"	--	--	--	--	250AA SS	--
	2" x 3"	SA 2030AL	--	--	--	2030AA SS	--
	3"	SA 300AL	--	SA 300BR	--	300AA SS	--
	3" x 4"	SA 3040AL	--	--	--	3040AA SS	--
	4"	SA 400AL	--	SA 400BR	--	400AA SS	--
	4" x 6"	SA 4060AL	--	--	--	4060AA SS	--
6"	SA 600AL	--	--	--	600AA SS	--	

Reducing Adapters and Couplers

 <p>AR</p>	Male Adapter x Female NPT		
	Size	Part #	List Price
	2" x 1-1/2"	AR 2015AL	--
	2" x 3"	AR 2030AL	--
	3" x 2"	AR 3020AL	--
	3" x 4"	AR 3040AL	--
	4" x 3"	AR 4030AL	--
	4" x 6"	AR 4060AL	--
6" x 4"	AR 6040AL	--	

 <p>BR</p>	Male Adapter x Female NPT		
	Size	Part #	List Price
	1-1/2" x 1"	BR 1510AL	--
	2" x 1-1/2"	BR 2015AL	--
	3" x 2"	BR 3020AL	--
	3" x 4"	BR 3040AL	--
	4" x 3"	BR 4030AL	--

Reducing Adapter and Coupler



Spool Adapter With Pipe Tap

AA

Size	Part #	List Price
2" X 2" x 1/2" NPT	200AA-1SS	--
2" X 2" x 3/4" NPT	200AA-2SS	--
3" X 3" x 1/2" NPT	300AA-1SS	--
3" X 3" X 3/4" NPT	300AA-2SS	--
3" X 3" X 1" NPT	300AA-3SS	--



Female Coupler x Female Coupler With Pipe Tap

DD-

Size	Part #	List Price
3" X 3" X 1/2" NPT	300DD-1SS	--
3" X 3" X 3/4" NPT	300DD-2SS	--



**Female Coupler x Male Adapter With Pipe Tap
Stainless Steel**

DA-

Size	Part #	List Price
3" x 2" x 1/2" NPT	3020DA-1SS	--
3" x 2" x 3/4" NPT	3020DA-2SS	--
3" x 2" x 1" NPT	3020DA-3SS	--
3" x 3" x 1/2" NPT	3030DA-1SS	--



**Female Coupler x Female Coupler
Stainless Steel**

DD

Size	Part #	List Price
1-1/2"	150DD SS	--
2"	200DD SS	--
2-1/2"	250DD SS	--
3"	300DD SS	--
3" x 4"	3040DD SS	--
4"	400DD SS	--



Female Coupler x Female NPT

DR

Size	Part #	List Price
1-1/2" x 1"	DR 1510AL	--
2" x 1-1/2"	DR 2015AL	--
3" x 2"	DR 3020AL	--
4" x 3"	DR 4030AL	--



Female Coupler x Female Coupler

DD

Size	Aluminum Part #	List Price	Brass Part #	List Price
1-1/2"	DD 150AL	--	--	--
2"	DD 200AL	--	--	--
3"	DD 300AL	--	--	--
3" x 2"	DD 3020AL	--	--	--
3" x 4"	DD 3040AL	--	--	--
4"	DD 400AL	--	DD 400BR	--

Reducing Adapter and Coupler

 <p>DA</p>	Size	Aluminum		Brass		Stainless Steel	
		Part #	List Price	Part #	List Price	Part #	List Price
	1-1/2" x 1"	DA 1510AL	--	--	--	DA 1510SS	--
	1-1/2" x 2"	DA 1520AL	--	--	--	DA 1520SS	--
	2" x 1 1/2"	DA 2015AL	--	--	--	DA 2015SS	--
	2" x 3"	DA 2030AL	--	--	--	DA 2030SS	--
	2" x 4"	DA 2040AL	--	--	--	DA 2040SS	--
	3" x 1-1/2"	DA 3015AL	--	--	--	DA 3015SS	--
	3" x 2"	DA 3020AL	--	DA 3020BR	--	DA 3020SS	--
	3" x 3"	--	--	--	--	DA 3030SS	--
	3" x 4"	DA 3040AL	--	DA 3040BR	--	DA 3040SS	--
	4" x 2"	DA 4020AL	--	--	--	DA 4020SS	--
	4" x 2.5"	--	--	--	--	DA 4025SS	--
	4" x 3"	DA 4030AL	--	DA 4030BR	--	DA 4030SS	--
4" x 6"	DA 4060AL	--	--	--	DA 4060SS	--	
6" x 4"	DA 6040AL	--	--	--	DA 6040SS	--	





316 Stainless Steel Reducer		
Part #	Description	List Price
3020N	3" Female NPSM x 2" Male NPT	--



316 Stainless Steel Reducer w/ BSP Straight Threads		
Part #	Description	List Price
3020BN	3" Female BSP X 2" Male NPT Stainless	--
3030BN	3" Female BSP X 3" Male NPT Stainless	--

Stainless Steel Reducer w/ BSP Straight Threads		
Part #	Description	List Price
3020ALBN	3" Female BSP X 2" Male NPT Aluminum	--
3030ALBN	3" Female BSP X 3" Male NPT Aluminum	--

 <p>Stainless Steel Pipe Cap 316 Stainless Steel</p>		
Part #	Description	List Price
PC 300SS	3" Female NPSH Pipe Cap	--
PC 300SSBSP	3" Stainless Cap w/ BSP Straight Thread	--
300TG	3" Gasket for Above	--
HC 300SS	Pipe Cap Hook	--

 <p>Fusible Pipe Cap 316 Stainless Steel</p>		
Part #	Description	List Price
FC 300SS	3" Female NPSM Fusible Pipe Cap	--
300TG	3" Gasket for Above	--

BSPT = British Standard Pipe Threads Tapered or Straight

BSPT = British Standard Pipe Threads Tapered or Straight



Reducing Adapter and Coupler



Lockable Dust Cap

DCL

Size	304 SS Part #	List Price	Size	Brass Part #	List Price
2"	LH 200SS	--	2"	DCL 200IBR	--
3"	LH 300SS	--	3"	DCL 300IBR	--
4"	LH 400SS	--	4"	DCL 400IBR	--

Size	Aluminum Part #	List Price	Size	316 SS Part #	List Price
2"	DCL 200IAL	--	1.5"	DCL 150SS	--
3"	DCL 300IAL	--	2"	DCL 200SS	--
4"	DCL 400IAL	--	3"	DCL 300SS	--
			4"	DCL 400SS	--



Female Coupler x Hose Shank

CR

Size	Aluminum Part #	List Price
2" x 1-1/2"	CR 2015AL	--
3" x 2"	CR 3020AL	--
3" x 4"	CR 3040AL	--
4" x 3"	CR 4030AL	--



Male Adapter x Hose Shank

ER

Size	Aluminum Part #	List Price
2" x 1-1/2"	ER 2015AL	--
2" x 3"	ER 2030AL	--
3" x 2"	ER 3020AL	--
3" x 4"	ER 3040AL	--
4" x 2"	ER 4020AL	--
4" x 3"	ER 4030AL	--



Hydrant Adapter
Cam Adapter with NST Fire Threads
Hard Coat Aluminum

HA

Part #	Description	List Price
HA 150AL	1-1/2" Adapter X 1-1/2" NST	--
HA 250AL	2-1/2" Adapter X 2-1/2" NST	--



Male Adapter x Male NPT

FR

Size	Aluminum Part #	List Price
2" x 1-1/2"	FR 1530AL	--
2" x 1-1/2"	FR 2015AL	--
2" x 3"	FR 2030AL	--
3" x 1-1/2"	FR 3015AL	--
3" x 2"	FR 3020AL	--
3" x 4"	FR 3040AL	--
4" x 2"	FR 4020AL	--
4" x 3"	FR 4030AL	--
4" x 6"	FR 4060AL	--

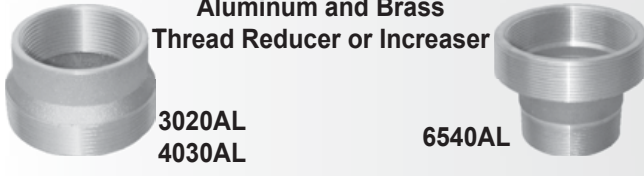

Aluminum and Brass Thread Reducer or Increaser

3020AL 4030AL 6540AL

Size	Aluminum Part #	List Price	Brass Part #	List Price
3" NPT-M x 2" NPT-F	3020AL	--	3020BR	--
4" NPT-M x 3" NPT-F	4030AL	--	4030BR	--
6" NPT-M x 5" NPT-F x 4" NPT-M	6540AL	--	--	--

Replacement Gaskets

The gasket materials listed below comprise a general guide to aid in the selection of the correct seal for customer application.

Buna N: Color **Code Blue**. Buna N is standard. It is generally recommended for petroleum derivatives, neutral or slightly acidic salt solutions, alcohols, ethers, glycols, fats, oils, and greases. This compound should give good service from **-40°F to +250°F**.

Neoprene: Color **Code Red**. Recommended for alkaline and acid salt solutions and aldehydes such as formaldehyde **-65°F to 250°F**.

***Viton A:** All are **Green**. Recommended for aromatics, hydrocarbons, liquid chlorine, carbon disulfide and molten sulfur. Viton A is not recommended for esters or the ketone family. This compound should offer good service **-40°F to 400°F**.

PTFE: The standard PTFE gasket is an envelope type design having a Neoprene Core. PTFE is recommended for highly oxidizing fluids, esters, ketones, and other liquids not generally handled by natural and synthetic rubbers **-40°F to 500°F**.

*PTFE encapsulated with silicon filler

EPDM - Ethylene-propylene rubber -Color **Code White** stripe. Excellent ozone, chemical, and aging resistance. Poor resistance to petroleum-based fluids.

**For use with 800IALPTK 8" cam-lock

Size	Package Qty.	Buna N Part Number	List Price	Buna N Extra Thick Part Number	List Price	Neoprene Part Number	List Price	*Viton-A Part Number	List Price
1/2"	25	050 BN	--	--	--	050 NE	--	050 VI	--
3/4"	25	075 BN	--	--	--	075 NE	--	075 VI	--
1"	25	100 BN	--	--	--	100 NE	--	100 VI	--
1-1/4"	25	125 BN	--	--	--	125 NE	--	125 VI	--
1-1/2"	25	150 BN	--	150 BX	--	150 NE	--	150 VI	--
2"	25	200 BN	--	200 BX	--	200 NE	--	200 VI	--
2-1/2"	25	250 BN	--	--	--	250 NE	--	250 VI	--
3"	15	300 BN	--	300 BX	--	300 NE	--	300 VI	--
4"	10	400 BN	--	400 BX	--	400 NE	--	400 VI	--
5"	--	500 BN	--	500 BX	--	500 NE	--	500 VI	--
6"	--	600 BN	--	600 BX	--	600 NE	--	600 VI	--
8"	--	800 BN	--	--	--	--	--	--	--
8"	--	800 BNPTK*	--	--	--	--	--	--	--

*For use with 8" PTK style cam lock

Size	Package Qty.	PTFE With Neoprene	List Price	PTFE Envelope with Silicone	List Price	EPDM Part Number	List Price	PTFE Encapsulated Silicon Filler Part #	List Price
3/4"	25	075 TF	--	--	--	075 EP	--	--	--
1"	25	100 TF	--	--	--	100 EP	--	--	--
1-1/4"	25	125 TF	--	--	--	125 EP	--	--	--
1-1/2"	25	150 TF	--	--	--	150 EP	--	150 TFCAP	--
2"	25	200 TF	--	--	--	200 EP	--	200 TFCAP	--
2-1/2"	25	250 TF	--	--	--	250 EP	--	250 TFCAP	--
3"	15	300 TF	--	300TFS	--	300 EP	--	300 TFCAP	--
4"	10	400 TF	--	--	--	400 EP	--	400 TFCAP	--
5"	--	500 TF	--	--	--	--	--	--	--
6"	--	600 TF	--	--	--	--	--	--	--

SPECIAL NOTE REGARDING GASKETS: All SFI couplers are supplied with Buna-N as standard. However, this sealing compound may **not** be compatible with all applications.

* Viton is a trademark of DuPont



Replacement Gaskets*

BUNA-N FDA

The gasket materials listed below comprise a general guide to aid in the selection of the correct seal for customer application.

Buna-N-FDA: Color Code **White**. It is generally recommended for food handling, neutral or slightly acidic salt solutions, alcohols, ethers, glycols, fats, oils, and greases. This compound should give good service from **-40°F to +250°F**.

Size	Package Qty.	Part Number	List Price	Size	Package Qty.	Part Number	List Price
1/2"	-	--	--	2-1/2"	25	250 FDA	--
3/4"	25	075 FDA	--	3"	15	300 FDA	--
1"	25	100 FDA	--	4"	10	400 FDA	--
1-1/4"	25	125 FDA	--	5"	--	500 FDA	--
1-1/2"	25	150 FDA	--	6"	--	600 FDA	--
2"	25	200 FDA	--	8"	--	--	--

Replacement Gaskets: All Seal Fast couplers are supplied with Buna-N as standard. This sealing compound may **not be compatible** with all applications.

The gasket materials listed below comprises a general guide to aid in the selection of the correct seal for customer application. Other factors must also be considered.

Buna-N: Color **code Blue**. Buna-N is standard. It is generally recommended for petroleum derivatives, natural or slightly acidic salt solutions, alcohols, ethers, glycols, fats, oils, and greases. This compound should give good service
From -40°F to +250° F.

Neoprene: Color **code Red**. Recommended for alkaline and acid salt solutions and aldehydes such as formaldehyde -65°F to 250°F.

***Viton A:** Color **code Green**. Recommended for aromatics, hydrocarbons liquid-chlorine, carbon disulfide and molten sulfur. *Viton A is not recommended for esters or the ketone family. This compound should offer good service -40°F to 400°F.

PTFE: The standard PTFE gasket is an envelope type design having a neoprene core. PTFE is recommended for highly oxidizing fluids, esters, ketones, and other liquids not generally handled by natural and synthetic rubbers.

TEMPERATURE RATINGS								
Gasket Material	Temperature Range in °F							
	500	400	300	275	250	200	150	0
Buna N				✓				-40
Neoprene					✓			-65
*Viton A		✓						-40
Silicone	✓							-30
*Teflon	✓							-40
Nat. Rubber						✓		-60
Butyl			✓					-40
Hypalon					✓			-65
EPDM							✓	

*Tetrafluorethylene Resin by DuPont viton & teflon are registered names.